

INSTRUKCJA WARSZTATOWA SYSTEMÓW RSP

info@rubbersystem.eu

www.rubbersystem.eu



Konstrukcja nośna

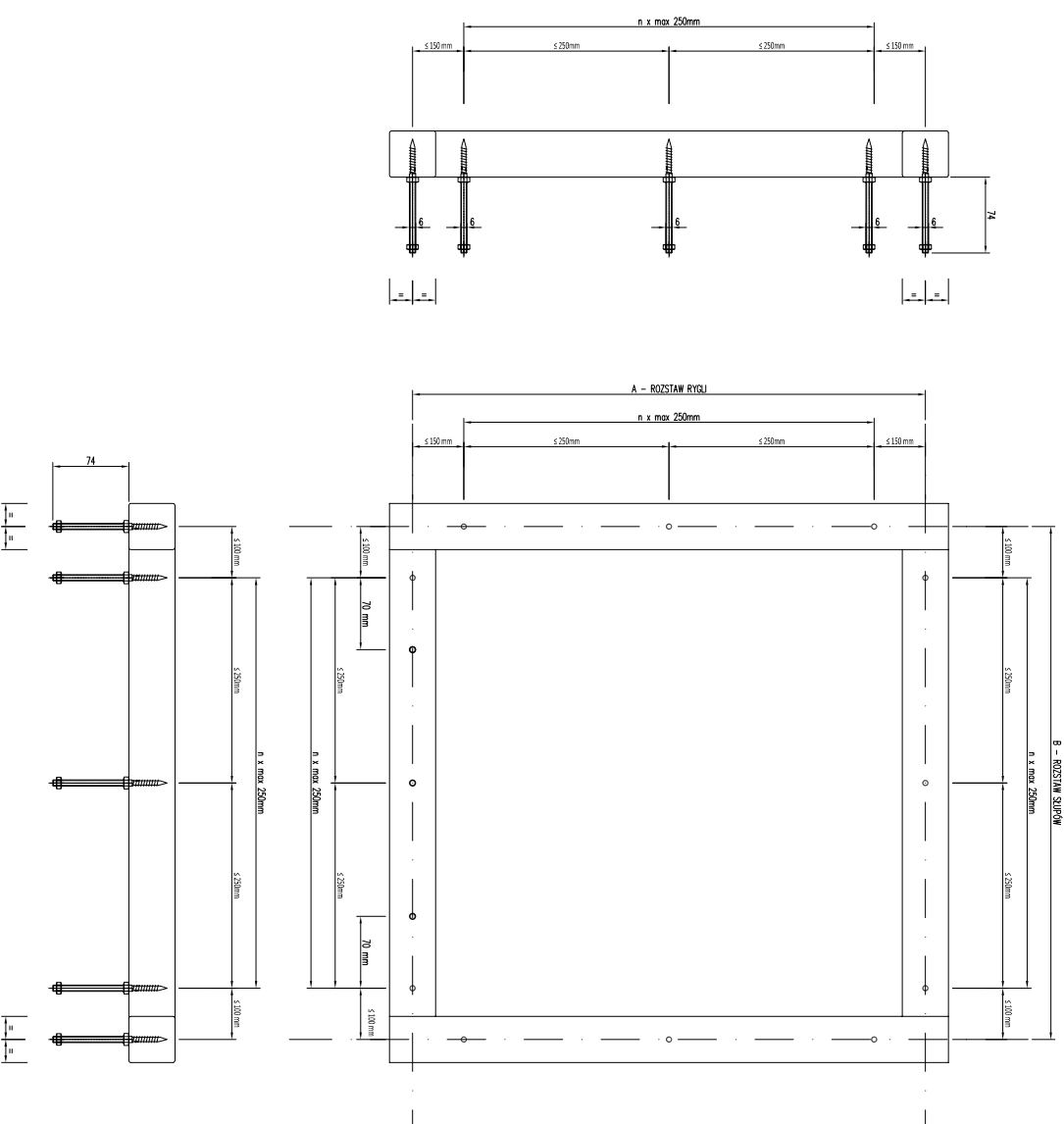

Konstrukcja nośna z dowolnego materiału konstrukcyjnego

Wymagania: maksymalne ugięcie $\leq L/200$ i 15mm, gdzie L - rozstaw podpór

SZKŁO

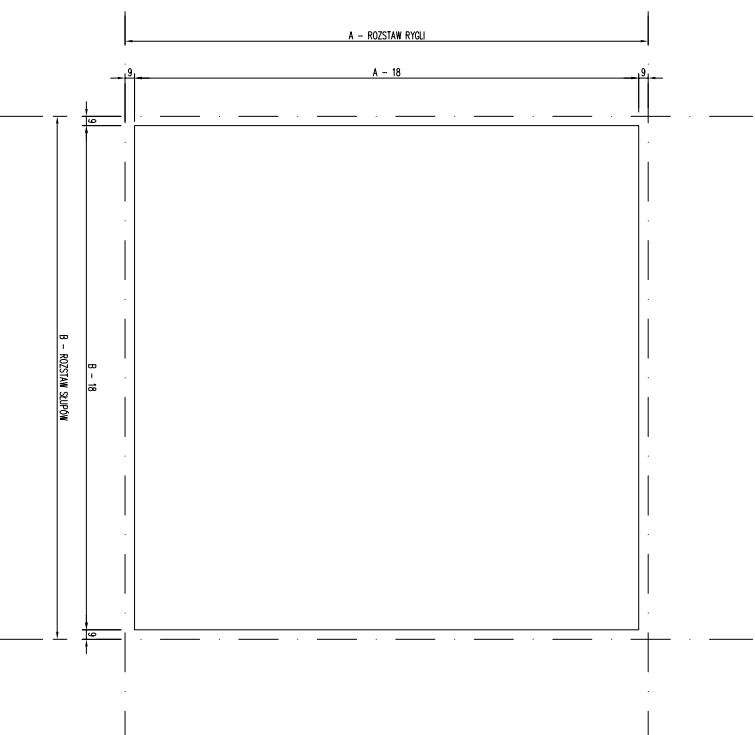
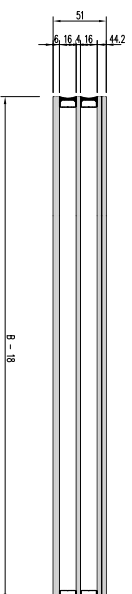
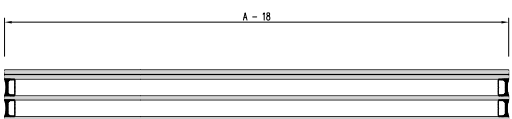

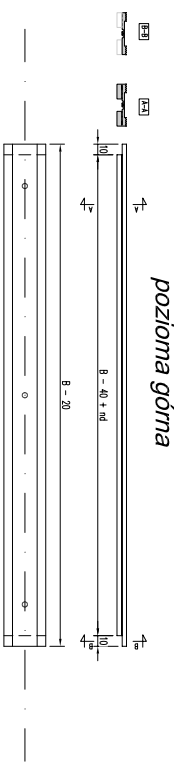

pozioma góra

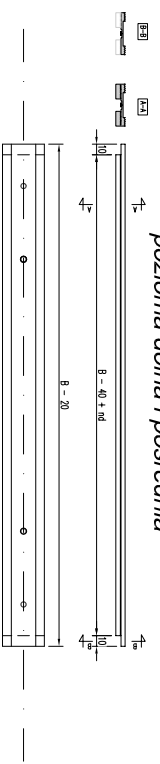

pozioma dolna i pośrodkia

pionowa lewa

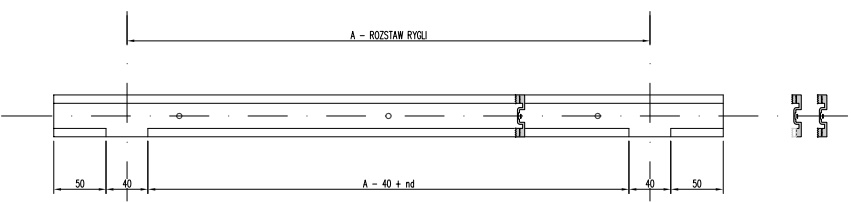

pionowa prawa

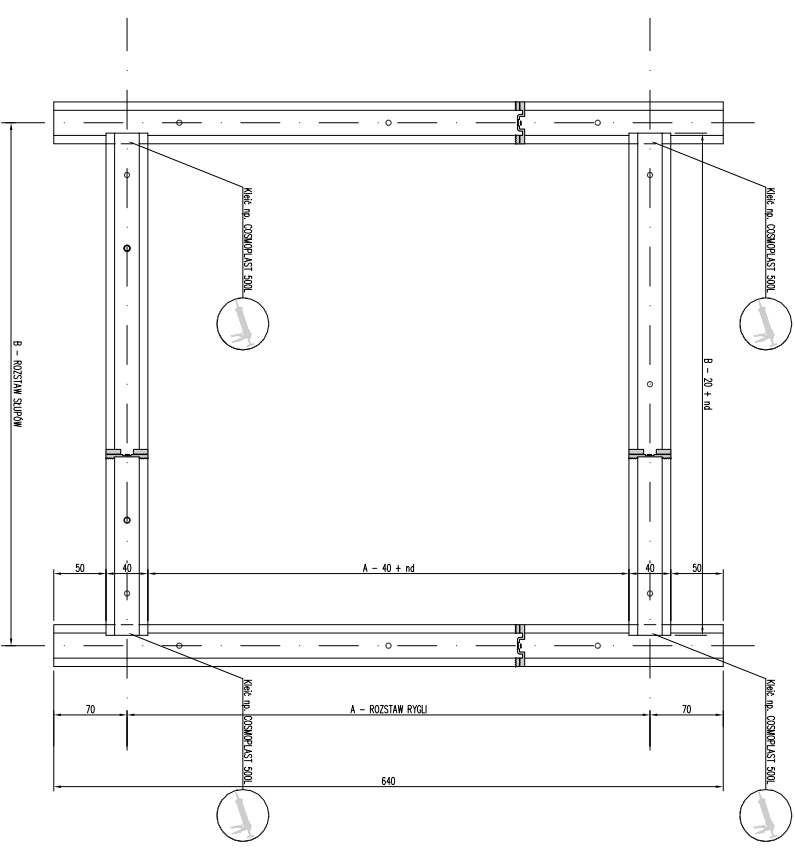
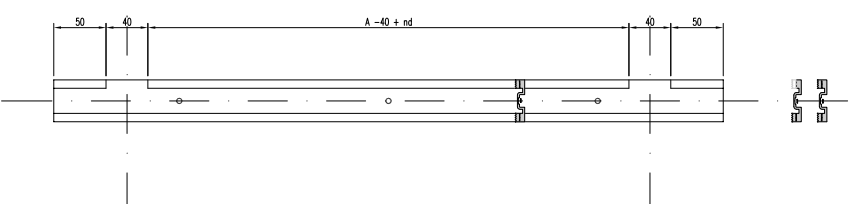

USZCZELKI WEWNĘTRZNE

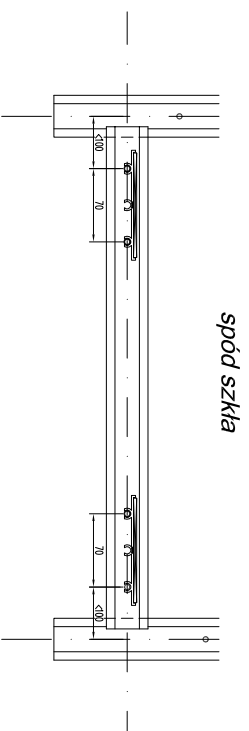

PODPÓRKI POD SZKŁO

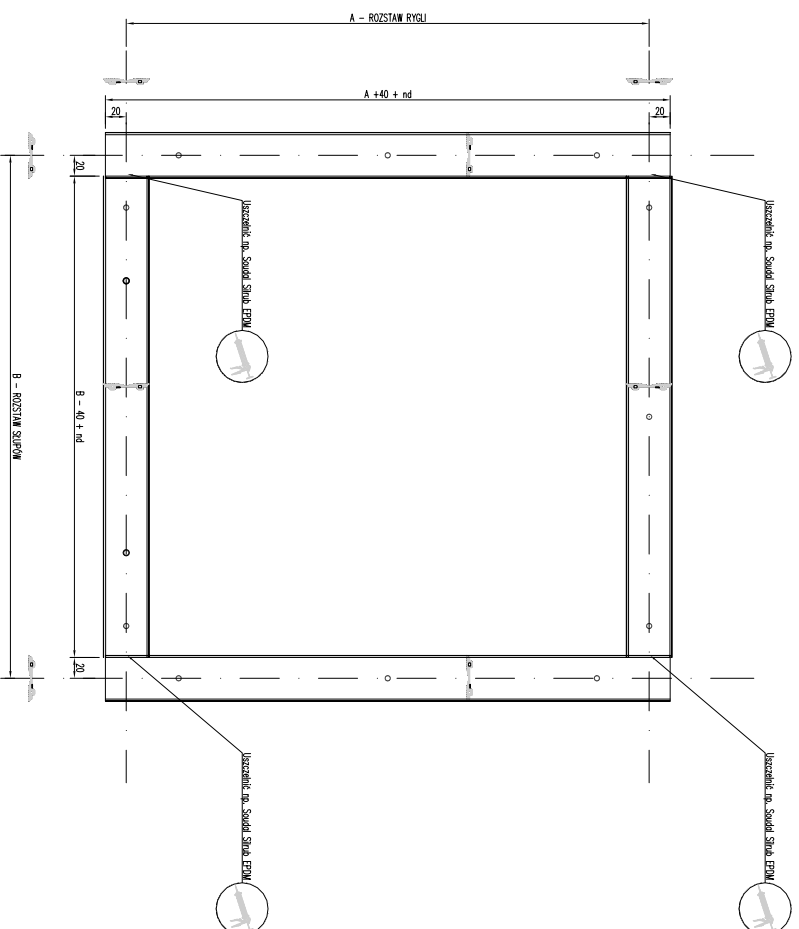

USZCZELKI ZEWNĘTRZNE

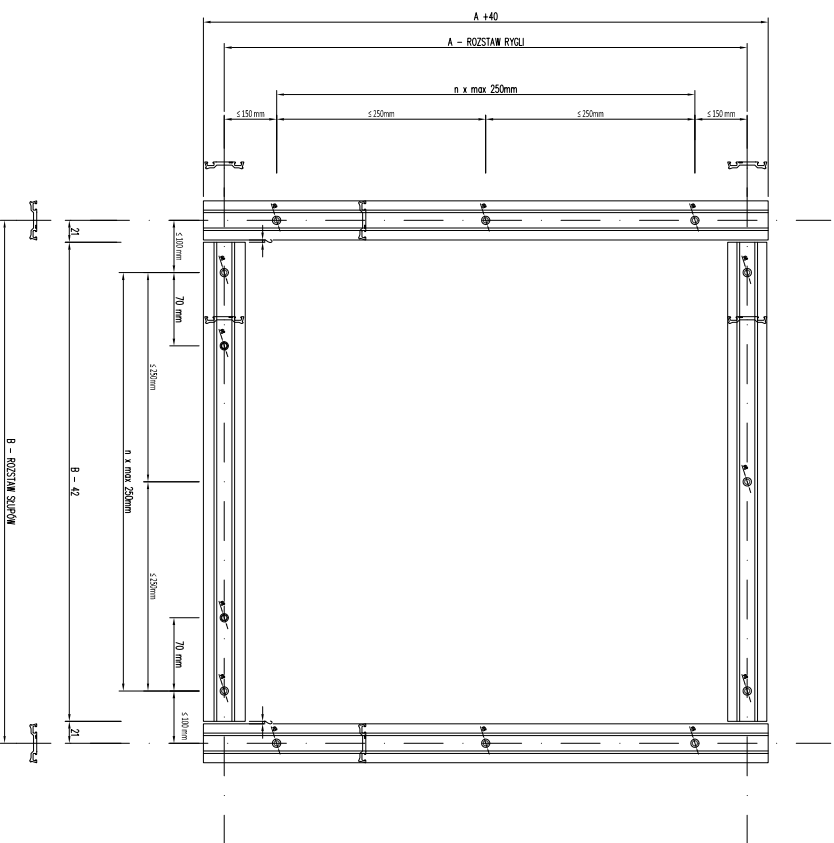

LISTWY DOCISKOWE

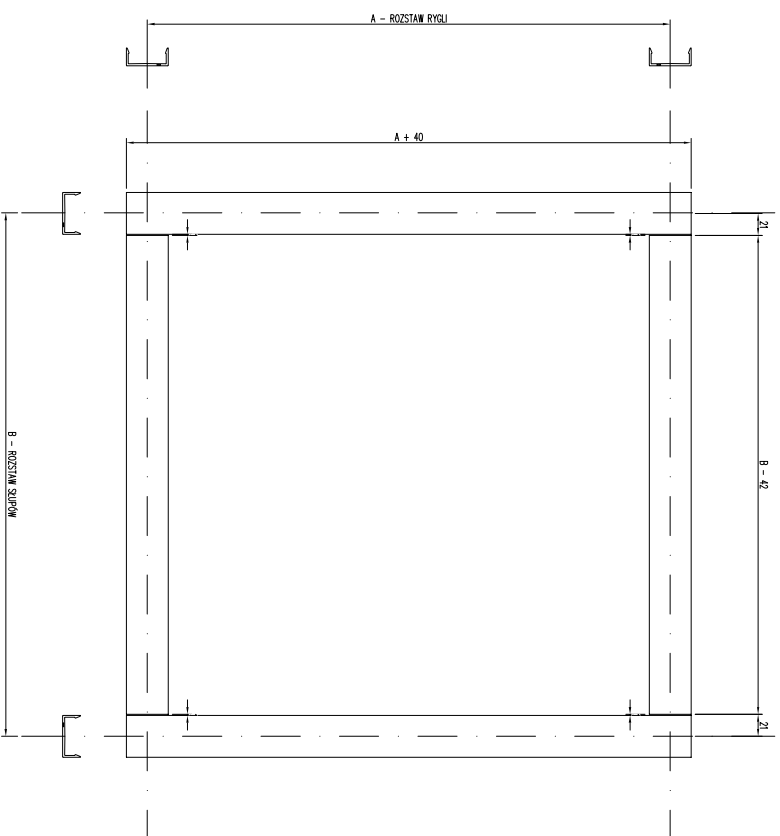

LISTWY MASKUJĄCE

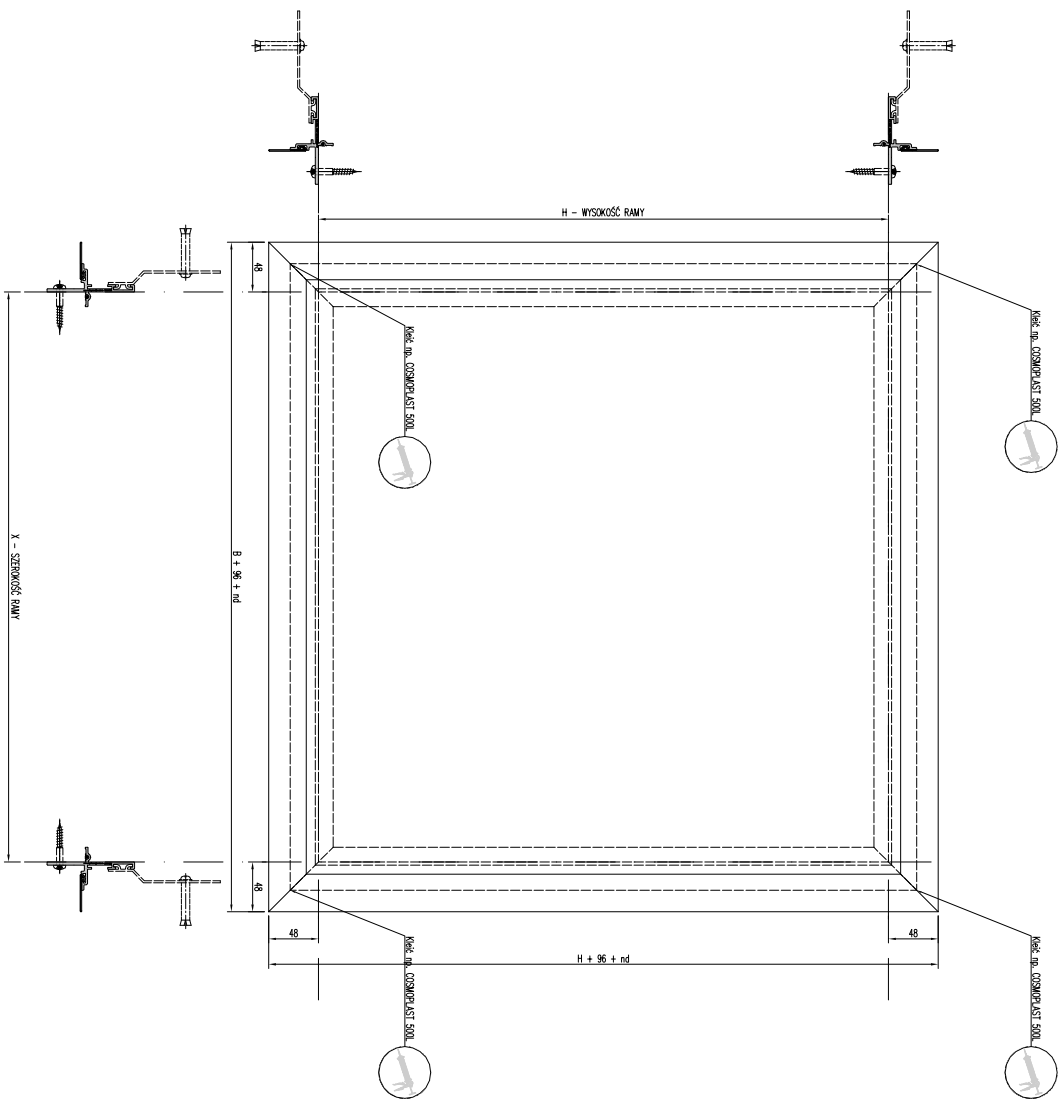
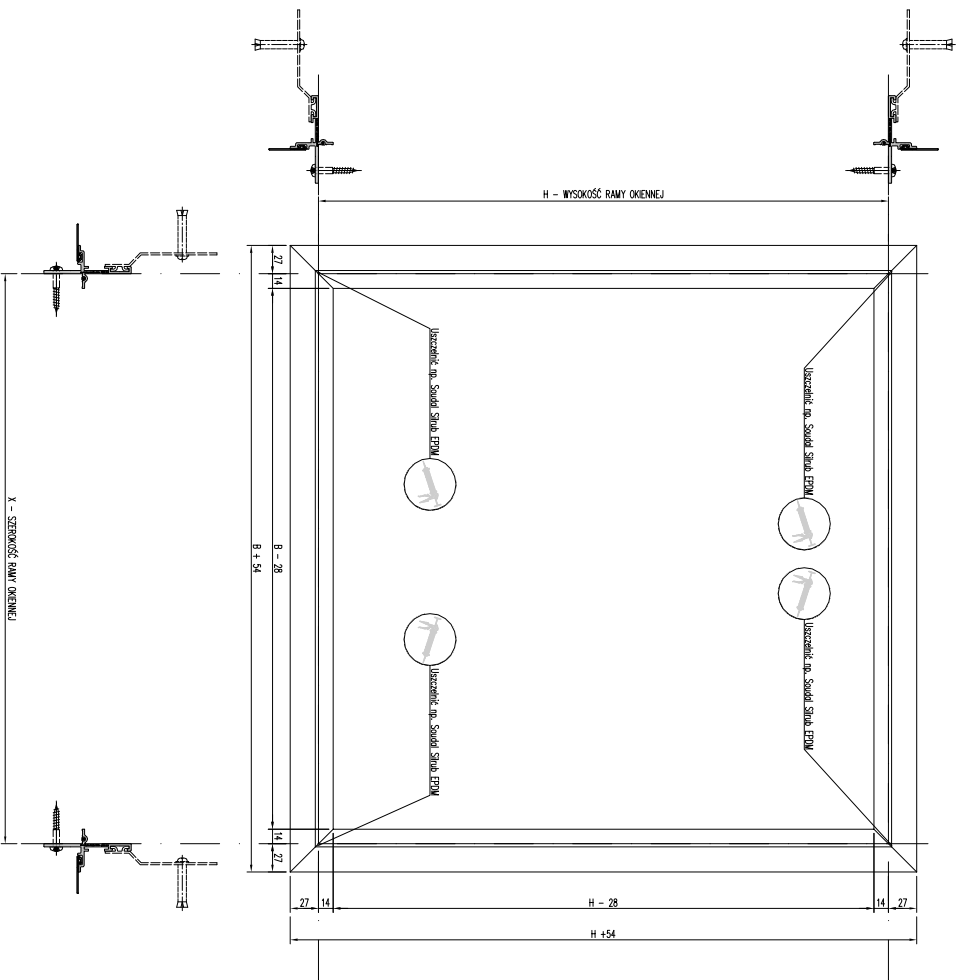

Mocowanie + uszczelnienie - uszczelka

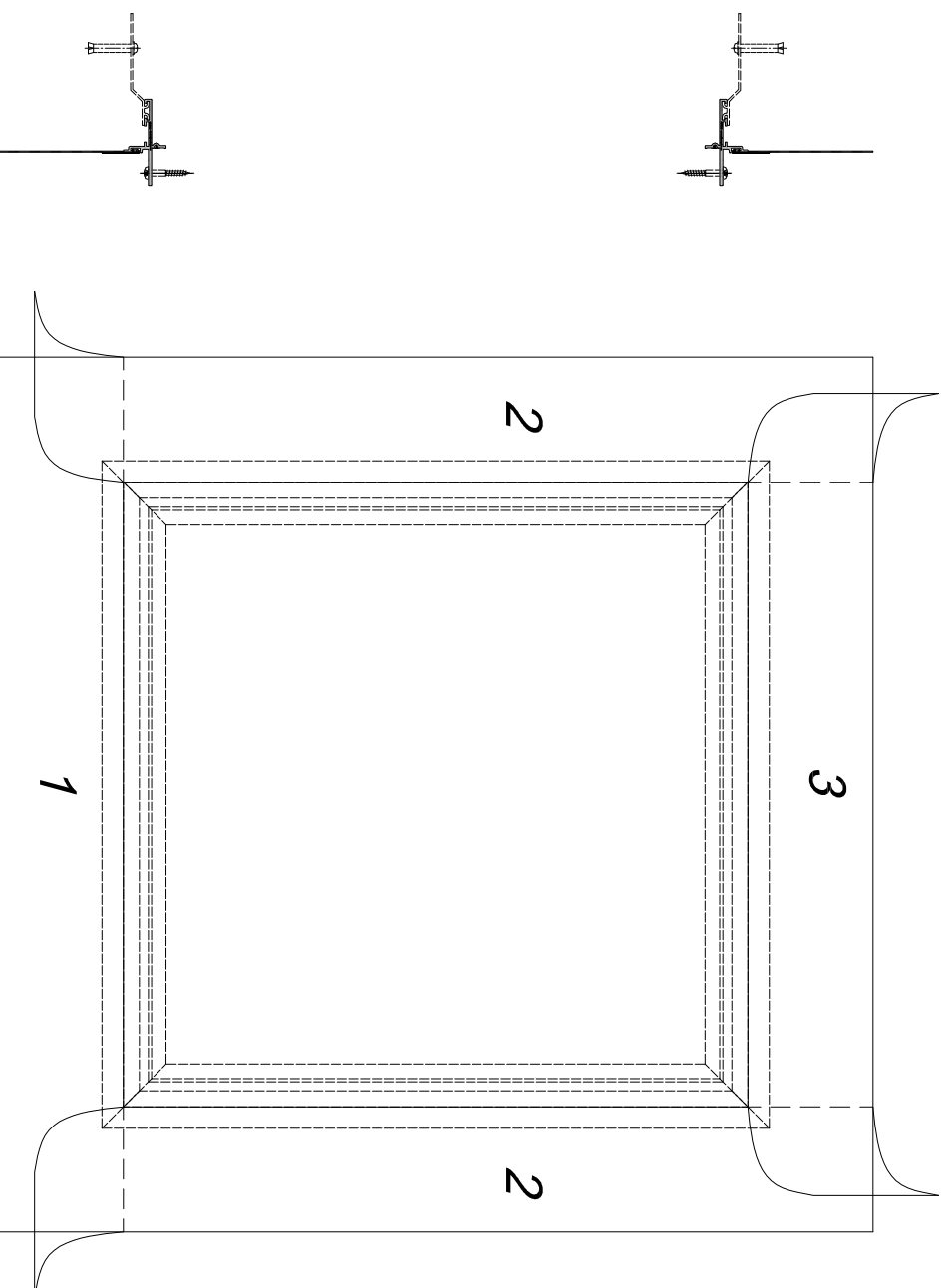
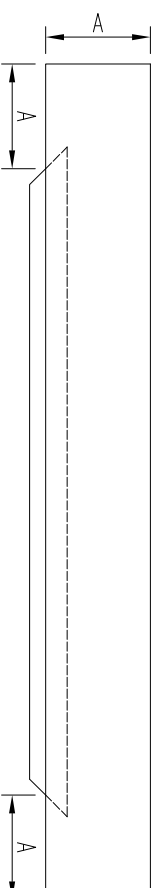

uszczelnienie - fartuch

